

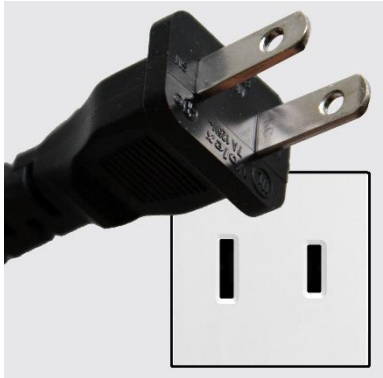

Plug types in key market countries

Contents

1. Type A to Type O page 1
2. Plug type for different countries page 7

Type	Appearance	Standard, Countries
A	 <p>NEMA 1-15</p>	<p>mainly used in the USA, Canada, Mexico, Japan & Taiwan</p> <p>2 pins, not grounded. 15 A</p> <p>almost always 100 - 127 V</p> <p>socket compatible with plug type A</p> <p>描述: 兩個平行扁腳, 無接地端</p>
B	 <p>NEMA 5-15</p>	<p>mainly used in the USA, Canada & Mexico & Taiwan</p> <p>3 pins, grounded, 15 A, almost always 100 - 127 V, socket compatible with plug types A & B</p> <p>美國、台灣、日本</p> <p>描述: (美規/接地) 兩個平行扁腳 + 一個圓形接地腳</p>
C	CEE 7/16	<p>Europlug</p> <p>commonly used in Europe, Africa, South America & Asia</p> <p>2 pins, not grounded, 2.5 A, 10 A & 16 A, almost always 220 - 240 V, socket compatible with plug type C</p> <p>歐洲多國、韓國、越南</p>

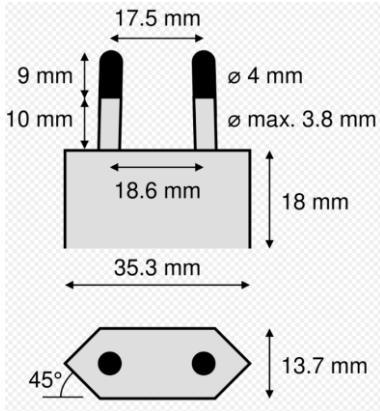

CEE 7/17

描述:歐規插頭 (Europlug) CEE 7/16 是一種雙圓柱形插腳的插頭，無接地腳，標準額定電流為 2.5 A。適用於 4 至 4.8 毫米寬的圓孔插座。兩個未接地的圓形插腳，中心間距為 19mm。

D



mainly used in **India** and its neighbouring countries

3 pins, Ground, 6 A, 220 - 240 V, socket compatible with plug type D (partial and unsafe compatibility with C, E & F)

BS546 5 A 版的 M 型

E



primarily used in **France, Belgium, Poland, Slovakia & Czechia**

2 pins, Grounded, 16 A, 220 – 240 V, socket compatible with plug types C, E & F

描述：法國插座是凹型設計，零火線是兩圓插孔，插座上方有根接地使用的圓形銅條。

F

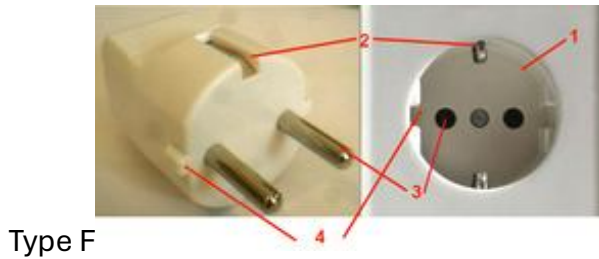

Type F



Schuko

used almost everywhere in Europe & Russia, except for the UK & Ireland

2 pins, Grounded, 16 A, 220 – 240 V, socket compatible with plug types C, E & F

德國、西班牙、韓國、奧地利、荷蘭、瑞典、挪威、芬蘭、俄羅斯

描述：（德規/Schuko）：兩根圓腳 + 兩側接地金屬片。Schuko 插座（德語：Schutzkontakt，意為「保護接觸」）是一種廣泛用於德國及多數歐洲國家的標準接地插座（CEE 7/3），它具備兩個圓形插孔和兩側的接地金屬片，在插入插頭時能先實現接地，確保高電氣安全性

插頭編號：CEE 7/4（純 Schuko）或 CEE 7/7（歐盟通用版）。

插座編號：CEE 7/3。

額定值：16 安培，250 伏特交流電（AC）

插座具備兩個 4.8 mm 的圓形孔，中間距

19 mm。常見款式帶有防塵蓋或安全鎖 (Shutter)。

G

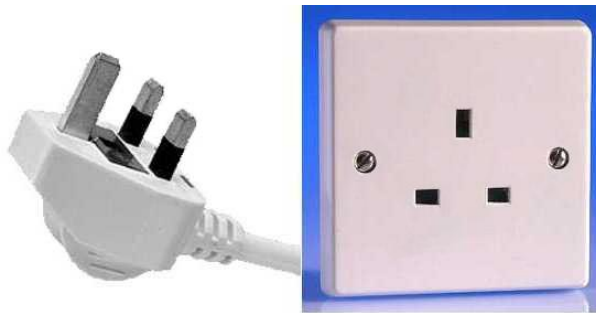
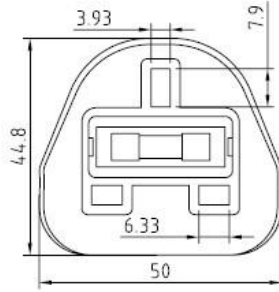

mainly used in the **United Kingdom, Ireland, Malta, Malaysia, Singapore & the Arabian Peninsula**

3 pins, Grounded, 13 A, 220 - 250 V, socket compatible with plug type G

BS 1363

英國、香港、新加坡、馬來西亞

描述:英國插頭。

三腳扁型三個方腳，呈三角排列。由兩橫零火線與一豎接地線組成。插頭的接地線插入插座之後才能打開插座的零火線保護門接通零火線。

H



used exclusively in **Israel**, the West Bank & the Gaza Strip

3 pins , Grounded, 16 A, 220 - 240 V, socket compatible with plug types C & H (partial and unsafe compatibility with E & F)

以色列

<p>I</p>	 <p>The image shows a black Type I plug with two flat, angled pins and one vertical grounding pin. Next to it is a white socket with two slanted slots and a vertical slot, labeled '10A 240V'.</p>	<p>mainly used in Australia, New Zealand, China & Argentina</p> <p>2 or 3 pins, 2 pins: not grounded, 3 pins: grounded, 10 A, 220 - 240 V, socket compatible with plug type I, AS/NZS 3112</p> <p>澳洲、紐西蘭、中國部分地區</p> <p>描述:兩個扁斜腳 (呈 V 形) + 一個垂直接地腳</p>
<p>J</p>	 <p>The image shows a black Type J plug with three round pins. Next to it is a light blue socket with a hinged cover and three round holes arranged in a triangle.</p>	<p>only used in Switzerland & Liechtenstein</p> <p>3 pins, Grounded, 10 A, 220 - 240 V, socket compatible with plug types C & J,</p> <p>描述:瑞士有自己國家的插頭插座標準，三個圓孔組成三角形，中間的圓孔為接地使用。</p>
<p>K</p>	 <p>The image shows a black Type K plug with two round pins and one semi-circular grounding pin. Next to it is a light grey socket with a hinged cover and two round holes for the main pins, and a semi-circular hole for the grounding pin.</p>	<p>only used in Denmark & its autonomous territories</p> <p>3 pins, Grounded, 16 A, 220 - 240 V, socket compatible with plug types C & K (partial and unsafe compatibility with E & F),</p> <p>描述:丹麥插座零火線是兩圓設計，接地線是半圓類型，乍看之下很像笑臉。</p>



L

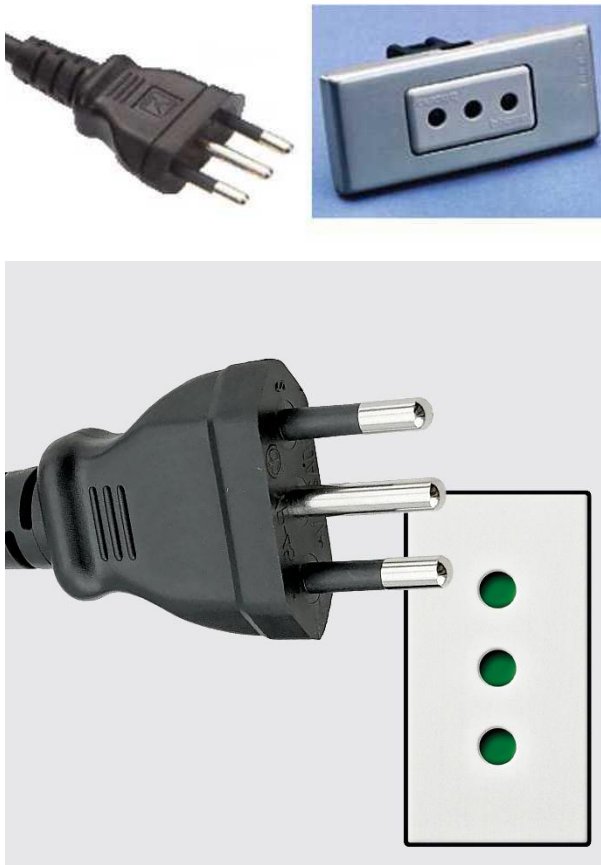

used almost exclusively in **Italy & Chile**

3 pins , Grounded, 10 A & 16 A, 220 - 240 V, 10 A socket compatible with plug types C & L (10 A version), 16 A socket compatible with plug type L (16 A version),



描述:義大利插座是三個圓孔設計，中間圓孔為接地使用。和瑞士插座不同的是，義大利插座三個圓孔在一平行線上。

M



mainly used in **South Africa**

3 pins , Grounded, 16 A, 220 - 240 V, socket compatible with plug type M,

N		<p>used in Brazil and South Africa</p> <p>3 pins, Grounded, 10 A, 16 A & 20 A, 100 - 240 V,</p> <p>socket compatible with plug types C & N</p>
O		<p>used exclusively in Thailand</p> <p>3 pins, Grounded, 16 A, 220 - 240 V,</p> <p>socket compatible with plug types C & O (partial and unsafe compatibility with E & F)</p>

Plug type for different countries







Asia Pacific				
Country	Voltage	Frequency	Plug Type	Remark
Australia/澳大利亞	230V	50Hz	I	China, Australia, NZ
New-Zealand/紐西蘭	230V	50Hz	I	China, Australia, NZ
Vietnam/越南	230V	50Hz	A, B, C	USA
Thailand/泰國	230V	50Hz	A, B, C, O	USA, Thailand
Malaysia/馬來西亞	230V	50Hz	G	UK BS1363
Singapore/新加坡	230V	50Hz	G	UK BS1363
Philippines/菲律賓	230V	60Hz	A, B, C	USA
Indonesia/印尼	230V	50Hz	C & F	Europlug, Schuko

Middle East				
Country	Voltage	Frequency	Plug Type	Remark
Saudi Arabia/沙烏地阿拉伯	230V	60Hz	G	UK BS1363
Kuwait/科威特	230V	50Hz	G	UK BS1363
Bahrain/巴林	230V	50Hz	G	UK BS1363
Dubai/杜拜	230V	50Hz	G	UK BS1363
United Arab Emirates (UAE)/阿拉伯聯合大公國	220-240V	50Hz	G	UK BS1363

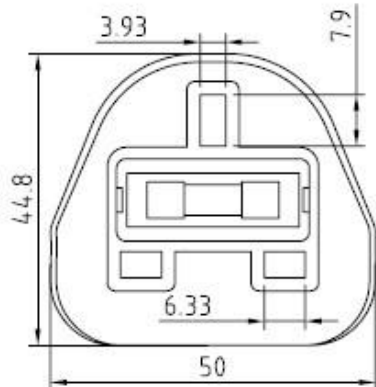
Europe				
Country	Voltage	Frequency	Plug Type	Remark
Poland/波蘭	230V	50Hz	C , E	Europlug, France
Hungary/匈牙利	230V	50Hz	C, F	Europlug, Schuko
Greece/希臘	230V	50Hz	C, F	Europlug, Schuko
Latvia/拉脫維亞	230V	50Hz	C, F	Europlug, Schuko
Slovakia/斯洛伐克	230V	50Hz	C, E	Europlug, France
United Kingdom (UK)	230V	50Hz	G	UK BS1363
France	230V	50Hz	C, E	Europlug, France
Turkey	230V	50Hz	C, F	Europlug, Schuko

Africa				
Country	Voltage	Frequency	Plug Type	Remark
Egypt	230V	50Hz	C, F	Europlug, Schuko
South Africa/南非	230V	50Hz	C, M, N	Europlug, South Africa, Brazil
Swaziland (officially Eswatini)/史瓦濟蘭	230V	50Hz	C, M, N	Europlug, South Africa, Brazil
Nigeria/奈及利亞	230V	50Hz	G	UK BS1363
Burkina Faso/布吉納法索	230V	50Hz	C, E	Europlug, France
Senegal/塞內加爾	230V	50Hz	C, E	Europlug, France
Malawi/馬拉威	230V	50Hz	G	UK BS1363



British

Country	British	Country	英國
Voltage 230V, Frequency 50Hz			
	BS 1363-1		
認證標誌 ASTA, HK, PSB, SASO, MS, GCC	 ASTA (United Kingdom)	1 BSI 	 HK(Hong Kong)
	 PSB(Singapore)	 SASO (Saudi Arabia)	 MS (Malaysia)
<ul style="list-style-type: none"> ◆ 標準規範：BS 1363/A ◆ 插頭類型：Type G ◆ 符合歐盟 EU REACH/ RoHS 危害性物質限制規範 ◆ 組裝式插頭(Molding Type / Non-Rewirable) ◆ 安規認證: BSI ◆ 額定電流/額定電壓 13A 250V~ 		<ul style="list-style-type: none"> ◆ Standard Specification: BS 1363/A ◆ Plug Type: Type G ◆ Complies with EU REACH/RoHS Hazardous Substance Restriction Standards ◆ Molding Type / Non-Rewirable Plug ◆ Safety Certification: BSI ◆ Rated Current/Rated Voltage: 13A 250V~ 	

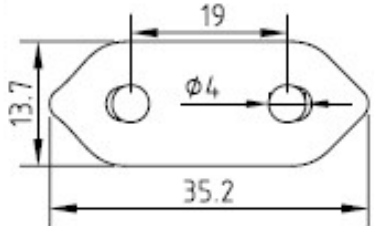

Country	British	Country	英國
Voltage 220V, Frequency 50Hz			
(主要)	(SASO)	英規三腳扁型 (Type G)	
認證標誌	1 BSI (UK)	2 SAFETY (Singapore)	3 SASO (Saudi Arabia)
			
<ul style="list-style-type: none"> ◆ 標準規範：SASO 2203 ◆ 插頭類型：Type G ◆ 應用產品:家電用品,個人電腦,螢幕,筆記型電腦等 ◆ 符合歐盟 EU REACH/ RoHS 危害性物質限制規範 ◆ 安規認證: BSI / SAFETY / SASO ◆ 產品敘述 ◆ LT-328 沙烏地阿拉伯認證電源線符合 SASO 2203 安規, 歐盟 EU REACH/RoHS 危害性物質限制指令規範標準。 ◆ ,英國 BSI 與新加坡 SAFETY 認證 ◆ 非組裝式插頭(Molding Type / Non-Rewirable) ◆ 額定電流/額定電壓 13A at 250V~ 		<ul style="list-style-type: none"> ◆ Standard Specification: SASO 2203 ◆ Plug Type: Type G ◆ Applications: Home appliances, personal computers, monitors, laptops, etc. ◆ Complies with EU REACH/RoHS Hazardous Substance Restriction Directives ◆ Safety Certifications: BSI / SAFETY / SASO ◆ Product Description: The LT-328 Saudi Arabian certified power cord complies with SASO 2203 safety regulations and EU REACH/RoHS Hazardous Substance Restriction Directive standards. ◆ British BSI and Singapore SAFETY certified. ◆ Molding Type / Non-Rewirable Plug ◆ Rated Current/Rated Voltage: 13A at 250V~ 	

Country	British	Country	英國
Voltage 220V, Frequency 50Hz			
	(SASO)		
認證標誌	1 BSI (UK) 	2 SAFETY (Singapore) 	3 SIRIM Malaysia 
			4 SASO (Saudi Arabia) 
<ul style="list-style-type: none"> 標準規範：BS 1363/A 插頭類型：Type G 應用產品:家電用品,個人電腦,螢幕,筆記型電腦...等 符合歐盟 EU REACH/ RoHS 危害性物質限制規範 安規認證: BSI / SAFETY / SIRIM / SASO 產品敘述 英規插頭符合 BS 1363/A,歐盟 EU REACH/RoHS 危害性物質限制指令規範標準。 亦有新加坡認證、沙烏地阿拉伯 SASO 認證，以及馬來西亞 SRIM 認證 組裝式插頭(Assembly Type / Rewirable) 產品特性 額定電流/額定電壓 3/5/10/13A 250V~ 		<ul style="list-style-type: none"> Standard Specification: BS 1363/A Plug Type: Type G Applications: Home appliances, personal computers, monitors, laptops, etc. Complies with EU REACH/RoHS Hazardous Substance Restriction Directives Safety Certifications: BSI / SAFETY / SIRIM / SASO Product Description: The UK standard plug complies with BS 1363/A and EU REACH/RoHS Hazardous Substance Restriction Directives. Also available are Singapore certification, Saudi Arabia SASO certification, and Malaysia SRIM certification. Assembly Type Plug Product Features: Rated Current/Rated Voltage: 3/5/10/13A 250V~ 	

Indonesia

Country	Indonesia	Country	印尼
Voltage 230V, Frequency 50Hz			
main			
認證標誌		1 SNI 	
<ul style="list-style-type: none"> ◆ 標準規範：SNI 04-3892.1-2006 ◆ 插頭類型：Type C ◆ 符合歐盟 EU REACH/ RoHS 危害性物質限制規範 ◆ 安規認證: SNI ◆ 額定電流/額定電壓 2.5A 250V~ 		<ul style="list-style-type: none"> ◆ Standard Specification: SNI 04-3892.1-2006 ◆ Plug Type: Type C ◆ Complies with EU REACH/RoHS Hazardous Substance Restriction Standards ◆ Safety Certification: SNI ◆ Rated Current/Rated Voltage: 2.5A 250V~ 	

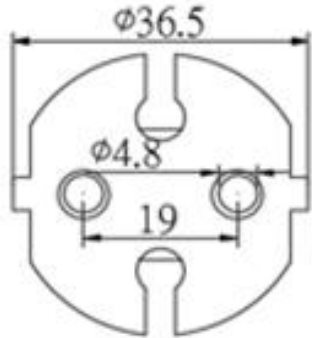
Country	Indonesia	Country	印尼
Voltage 230V, Frequency 50Hz			
			
認證標誌		1 SNI 	
<p>標準規範：SNI 04-3892.1-2006</p> <p>插頭類型：Type E / Type F</p> <p>符合歐盟 EU REACH/ RoHS 危害性物質限制規範</p> <p>安規認證: SNI</p> <p>額定電流/額定電壓 16A 250V~</p>		<p>Standard Specification: SNI 04-3892.1-2006</p> <p>Plug Type: Type E / Type F</p> <p>Complies with EU REACH/RoHS Hazardous Substance Restriction Standards</p> <p>Safety Certification: SNI</p> <p>Rated Current/Rated Voltage: 16A 250V~</p>	
<p>歐規大圓款（4.8mm）插頭，屬於常見的兩腳圓柱插頭（E, F 型）。其插腳較粗，常為轉接頭或延長線的設計核心，</p> <p>歐規大圓（4.8mm）關鍵資訊：</p> <p>適用地區：</p> <p>歐洲地區：奧地利,比利時,克羅地亞,捷克共和國,丹麥,愛沙尼亞,芬蘭,法國,德國,希臘,匈牙利,冰島,愛爾蘭,義大利,盧森堡,荷蘭,挪威,波蘭,葡萄牙,羅馬尼亞,斯洛伐克,斯洛文尼亞,西班牙,瑞典,瑞士,土耳其,烏克蘭,</p> <p>非洲地區：,阿爾及利亞,埃及,突尼斯,摩洛哥,</p> <p>亞洲地區：,印尼,土耳其,韓國,亞美尼亞,沙烏地阿拉伯,不丹,緬甸,寮國。</p> <p>插頭規格： 兩根 4.8mm 的圓柱腳（Type E/F）。</p>		<p>The European standard 4.8mm round plug. It is a common two-prong round plug (Type E, F). Its prongs are thicker and are often the core design element of adapters or extension cords.</p> <p>Key information about the European standard 4.8mm round plug:</p> <p>Applicable regions:</p> <p>Europe: Austria, Belgium, Croatia, Czech Republic, Denmark, Estonia, Finland, France, Germany, Greece, Hungary, Iceland, Ireland, Italy, Luxembourg, Netherlands, Norway, Poland, Portugal, Romania, Slovakia, Slovenia, Spain, Sweden, Switzerland, Turkey, Ukraine;</p> <p>Africa: Algeria, Egypt, Tunisia, Morocco;</p> <p>Asia: Indonesia, Turkey, South Korea, Armenia, Saudi Arabia, Bhutan, Myanmar, Laos.</p> <p>Plug specifications: Two 4.8mm round prongs (Type E/F).</p>	

Country	Indonesia	Country	印尼
Voltage 230V, Frequency 50Hz			
			
認證標誌		<p>1 SNI</p> 	
<p>標準規範：SNI 04-3892.1-2006</p> <p>插頭類型：Type E / Type F</p> <p>符合歐盟 EU REACH/ RoHS 危害性物質限制規範</p> <p>安規認證: SNI</p> <p>額定電流/額定電壓 16A 250V~</p>		<p>Standard Specification: SNI 04-3892.1-2006</p> <p>Plug Type: Type E / Type F</p> <p>Complies with EU REACH/RoHS Hazardous Substance Restriction Standards</p> <p>Safety Certification: SNI</p> <p>Rated Current/Rated Voltage: 16A 250V~</p>	



Kuwait

Country	Kuwait	Country	科威特
Voltage 230V, Frequency 50Hz			
main		Type G (BS-1363). 	
認證標誌		 KUCAS	
<ul style="list-style-type: none"> ◆ 符合歐盟 EU REACH/ RoHS 危害性物質限制規範 ◆ 非組裝式插頭(Molding Type / Non-Rewirable) ◆ 額定電流/額定電壓 13A at 250V~ 		<ul style="list-style-type: none"> ◆ Complies with EU REACH/RoHS Hazardous Substance Restriction Standards ◆ Product Description: Molding Type / Non-Rewirable Plug ◆ Rated Current/Rated Voltage: 13A at 250V~ 	



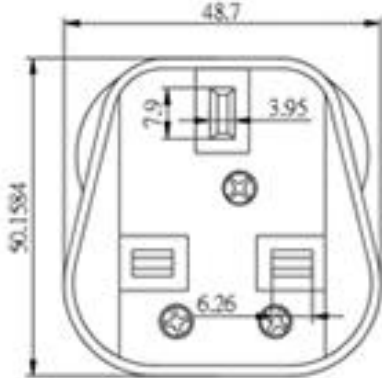

Saudi Arabia

Country	Saudi Arabia	Country	沙烏地阿拉伯
Voltage 220V, Frequency 50Hz			
BS-1363		Type G (BS-1363). 	
認證標誌	1 BSI 	2 SAFETY 	3 SASO 
<ul style="list-style-type: none"> ◆ 標準規範：SASO 2203 ◆ 符合歐盟 EU REACH/ RoHS 危害性物質限制規範 ◆ 安規認證: BSI / SAFETY / SASO ◆ 沙烏地阿拉伯認證電源線符合 SASO 2203 安規, 歐盟 EU REACH/RoHS 危害性物質限制指令規範標準。 ◆ ,英國 BSI 與新加坡 SAFETY 認證 ◆ 非組裝式插頭(Molding Type / Non-Rewirable) ◆ 額定電流/額定電壓 13A at 250V~ 		<ul style="list-style-type: none"> ◆ Standard Specification: SASO 2203 ◆ Applications: Home appliances, personal computers, monitors, laptops, etc. ◆ Complies with EU REACH/RoHS Hazardous Substance Restriction Directives ◆ Safety Certifications: BSI / SAFETY / SASO ◆ Saudi Arabian certified power cord complies with SASO 2203 safety regulations and EU REACH/RoHS Hazardous Substance Restriction Directive standards. ◆ British BSI and Singapore SAFETY certified. ◆ Molding Type / Non-Rewirable Plug ◆ Rated Current/Rated Voltage: 13A at 250V~ 	

Country	Saudi Arabia	Country	沙烏地阿拉伯
Voltage 220V, Frequency 50Hz			
BS 1363/A			
認證標誌	1 BSI 	2 SAFETY 	3 SIRIM 
			4 SASO 
<ul style="list-style-type: none"> ◆ 標準規範：BS 1363/A ◆ 插頭類型：Type G ◆ 符合歐盟 EU REACH/ RoHS 危害性物質限制規範 ◆ 安規認證: BSI / SAFETY / SIRIM / SASO ◆ 英規插頭符合 BS 1363/A, 歐盟 EU REACH/RoHS 危害性物質限制指令規範標準。 ◆ 亦有新加坡認證、沙烏地阿拉伯 SASO 認證，以及馬來西亞 SRIM 認證 ◆ 組裝式插頭(Assembly Type / Rewirable) ◆ 產品特性 ◆ 額定電流/額定電壓 13A 250V~ 		<ul style="list-style-type: none"> ◆ Standard Specification: BS 1363/A ◆ Plug Type: Type G ◆ Complies with EU REACH/RoHS Hazardous Substance Restriction Directives ◆ Safety Certifications: BSI / SAFETY / SIRIM / SASO ◆ UK standard plug complies with BS 1363/A and EU REACH/RoHS Hazardous Substance Restriction Directives. ◆ Also available are Singapore certification, Saudi Arabia SASO certification, and Malaysia SRIM certification. ◆ Assembly Type / Rewirable ◆ Rated Current/Rated Voltage: 13A 250V~ 	

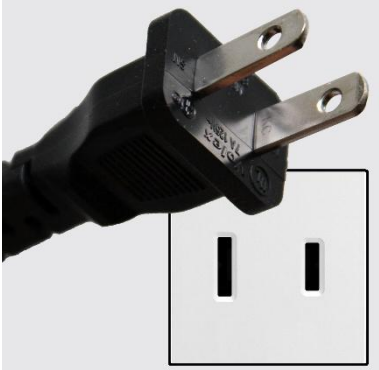

Country	Saudi Arabia	Country	沙烏地阿拉伯
Voltage 220V, Frequency 50Hz			
			
認證標誌		<p data-bbox="552 680 624 707">1 GC</p> 	
<ul style="list-style-type: none"> ◆ 安規認證: GC ◆ 額定電流/額定電壓 13A 250V~ 		<ul style="list-style-type: none"> ◆ Safety Certification: GC ◆ Rated Current/Rated Voltage 13A 250V~ 	

Tailand

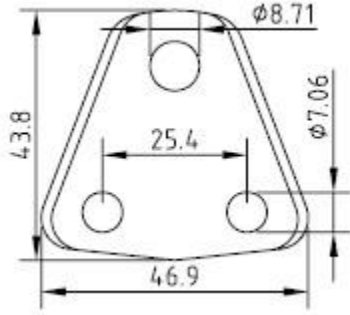

Country	Tailand	Country	泰國
Voltage 230V, Frequency 50Hz			
		<p>Type A</p> 	<p>Type B</p> 
		<p>Type C</p> 	<p>Type O</p> 
Standard		 <p>มทท. 2217-2548</p> <p>TISI TIS 2217-2548, TIS 1195-2536</p>	

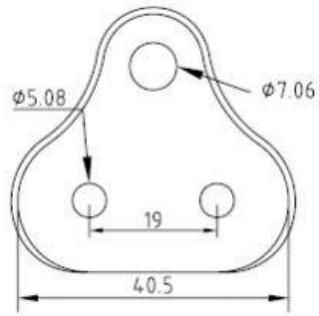
South Africa

Country	South Africa	Country	南非
Voltage 230V, Frequency 50Hz			
			
認證標誌		1	
<ul style="list-style-type: none"> 標準規範：SABS 164/1, BS 546 插頭類型：Type M 符合歐盟 EU REACH/ RoHS 危害性物質限制規範 安規認證: NA 額定電流/額定電壓 16A 250V~ 		<ul style="list-style-type: none"> Standard Specifications: SABS 164/1, BS 546 Plug Type: Type M Complies with EU REACH/RoHS Hazardous Substance Restriction Standards Safety Certification: NA Rated Current/Voltage: 16A 250V~ 	

Country	南非	Country	South Africa
Voltage 230V, Frequency 50Hz			
			
認證標誌		1 	
<ul style="list-style-type: none"> 標準規範：SABS 164/1 插頭類型：Type M 符合歐盟 EU REACH/ RoHS 危害性物質限制規範 安規認證: NA 額定電流/額定電壓 10A 250V~ 		<ul style="list-style-type: none"> Standard Specification: SABS 164/1 Plug Type: Type M Complies with EU REACH/RoHS Hazardous Substance Restriction Standards Safety Certification: NA Rated Current/Voltage: 10A 250V~ 	

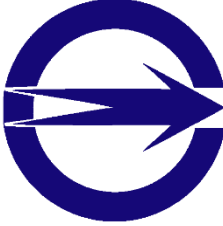
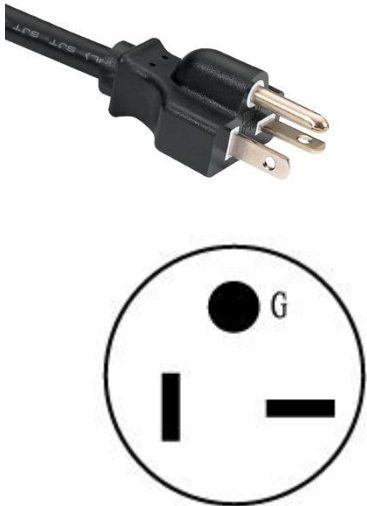





Taiwan



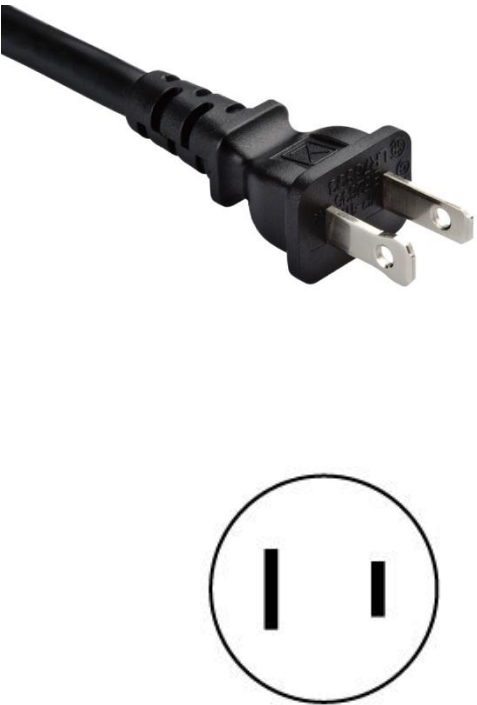

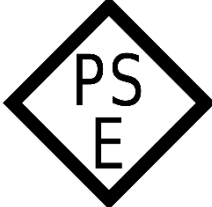

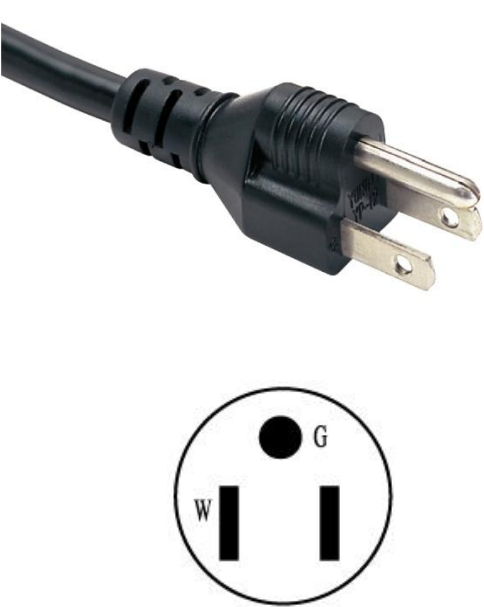

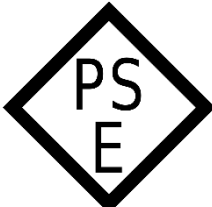
Country	Taiwan	Country	台灣
(1)Voltage 110V, Frequency 60Hz (2)Voltage 220V, Frequency 60Hz			
NEMA 6-20P		<p>標準號碼 CNS 690 安規認證 BSMI 最大電流 20A 最大電壓 250V 環保認證 RoHS, REACH</p>	<p>認證標誌 1 BSMI</p> 
NEMA 6-20P			<p>認證標誌 1 UL/cULus(USA & Canada)</p> 



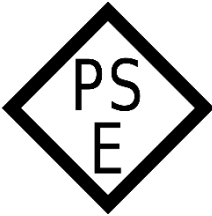

Turkey

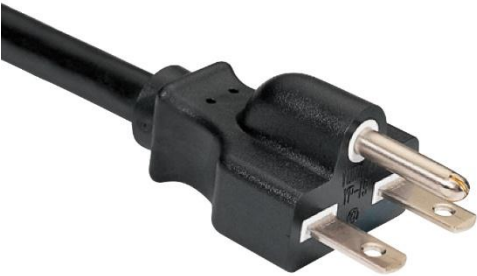
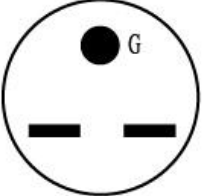



Country	Turkey	Country	土耳其
Voltage 230V, Frequency 50Hz			
Standard		TSE	
			

USA

Country	USA	Country	美國
(1)Voltage 110V, Frequency 60Hz (2)Voltage 220V, Frequency 60Hz			
<p>NEMA 1-15P</p>		<p>Certification UL/cULus (USA & Canada) Cert. No. : UL 817, JIS C 8303, CNS 6797 RoHS, REACH Max. Current 15A Max. Voltage 125V</p> <p>標準號碼 UL 817, JIS C 8303, CNS 6797 安規認證 UL/cULus, PSE, BSMI 最大電流 15A 最大電壓 125V 環保認證 RoHS, REACH</p>	<p>認證標誌 1 UL/cULus (USA & Canada)</p>  <p>2 PSE (Japan)</p>  <p>3 BSMI (Taiwan)</p> 
<p>NEMA 1-15P</p>		<p>Certification UL/cULus (USA & Canada) Cert. No. : UL 817, JIS C 8303, CNS 6797 RoHS, REACH Max. Current 15A Max. Voltage 125V</p> <p>標準號碼 UL 817, JIS C 8303, CNS 6797 安規認證 UL/cULus, PSE, BSMI 最大電流 15A 最大電壓 125V</p>	<p>認證標誌 1 UL/cULus (USA & Canada)</p>  <p>2 PSE (Japan)</p>  <p>3 BSMI (Taiwan)</p>

		環保認證 RoHS, REACH	
NEMA 5-15P JIS C 8303 CNS 690	 	Certification UL/cULus (USA & Canada) Cert. No.: UL 817, JIS C 8303, CNS 6797 RoHS, REACH Max. Current 15A Max. Voltage 125V 標準號碼 UL 817, JIS C 8303, CNS 6797 安規認證 UL/cULus, PSE, BSMI 最大電流 15A 最大電壓 125V 環保認證 RoHS, REACH	1 UL/cULus(USA & Canada)  2 PSE (Japan)  3 BSMI (Taiwan) 
NEMA 6-19P	 	Certification UL/cULus (USA & Canada) RoHS, REACH Cert. No.: UL 817, Max. Current 15A Max. Voltage 250V	認證標誌 UL/cULus (USA & Canada) 環保認證 RoHS, REACH 標準號碼 UL 817, 最大電流 15A 最大電壓 250V 

<p>NEMA 6-20P</p>		<p>Certification UL/cULus (USA & Canada) RoHS, REACH Cert. No.: UL 817, Max. Current 20A Max. Voltage 250V</p> 	<p>認證標誌 UL/cULus (USA & Canada) 環保認證 RoHS, REACH 標準號碼 UL 817, 最大電流 20A 最大電壓 250V</p>
<p>NEMA 6-20P</p>		<p>Certification UL/cULus (USA & Canada) RoHS, REACH Cert. No.: UL 817, Max. Current 20A Max. Voltage 250V</p> 	<p>認證標誌 UL/cULus (USA & Canada) 環保認證 RoHS, REACH 標準號碼 UL 817, 最大電流 20A 最大電壓 250V</p>

<p>NEMA 6-30P</p>		<p>Certification UL/cULus (USA & Canada) RoHS, REACH Cert. No.: UL 817, Max. Current 30A Max. Voltage 250V</p> 	<p>認證標誌 UL/cULus (USA & Canada) 環保認證 RoHS, REACH 標準號碼 UL 817, 最大電流 30A 最大電壓 250V</p>
<p>NEMA 6-50P</p>		<p>Certification UL/cULus (USA & Canada) RoHS, REACH Cert. No.: UL 817, Max. Current 50A Max. Voltage 250V</p> 	<p>認證標誌 UL/cULus (USA & Canada) 環保認證 RoHS, REACH 標準號碼 UL 817, 最大電流 50A 最大電壓 250V</p>